

Kicad specific stuff for ERC validation.
This doesn't correspond to any specific component.

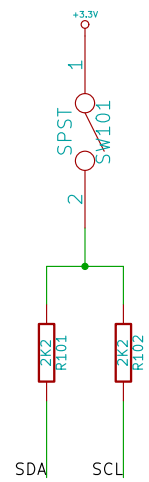

Pullups

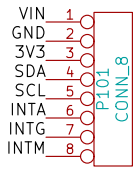
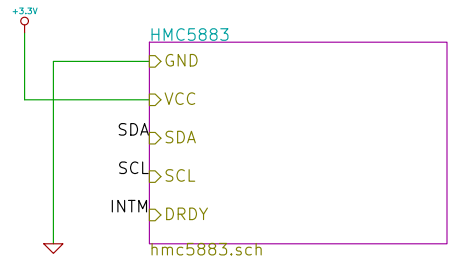
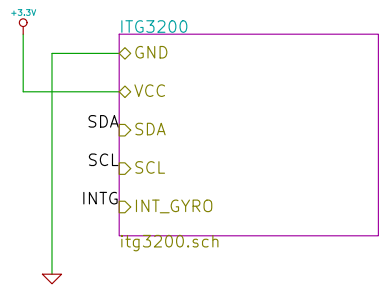
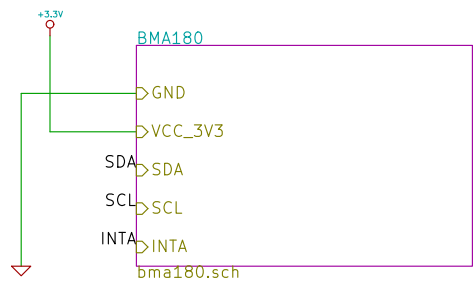
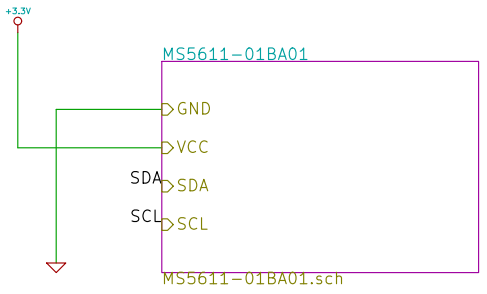
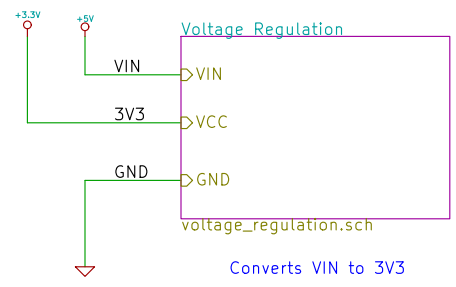

Released under CC-BY-SA 3.0 Unported
<http://creativecommons.org/licenses/by-sa/3.0/>
Fabio Varesano - varesano.net

File: FreeIMU_factory.sch
Sheet: /

Title: FreeIMU

Size: A4 **Date: 10 jul 2011**

KiCad E.D.A.

Rev: 0.3.5_M

Id: 1/6

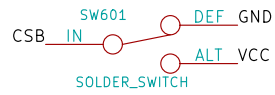
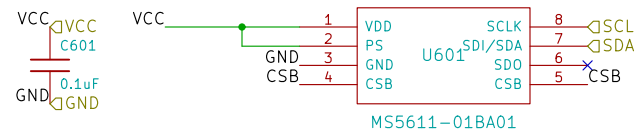

Released under CC-BY-SA 3.0 Unported http://creativecommons.org/licenses/by-sa/3.0/		
Fabio Varesano - varesano.net		
File: MS5611-01BA01.sch		
Sheet: /MS5611-01BA01/		
Title: FreelMU		
Size: A4	Date: 10 jul 2011	Rev: 0.3.5_M
KiCad E.D.A.		Id: 2/6

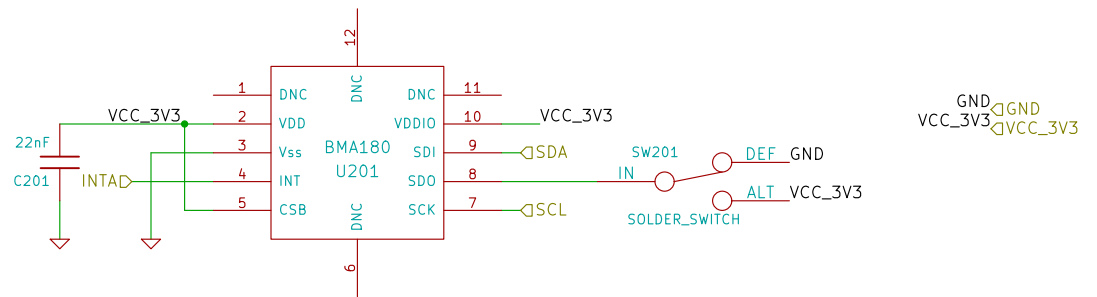

Released under CC-BY-SA 3.0 Unported
<http://creativecommons.org/licenses/by-sa/3.0/>

Fabio Varesano - varesano.net

File: bma180.sch

Sheet: /BMA180/

Title: FreeIMU

Size: A4

Date: 10 jul 2011

Rev: 0.3.5_M

KiCad E.D.A.

Id: 3/6

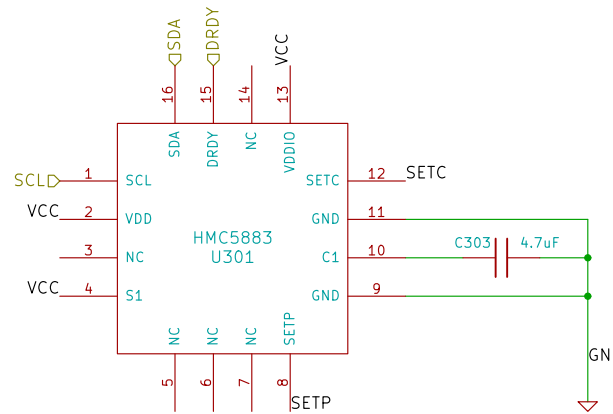
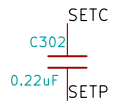

GND GND

VCC VCC

Released under CC-BY-SA 3.0 Unported http://creativecommons.org/licenses/by-sa/3.0/		
Fabio Varesano - varesano.net		
File: hmc5883.sch Sheet: /HMC5883/		
Title: FreelMU		
Size: A4	Date: 10 jul 2011	Rev: 0.3.5_M
KiCad E.D.A.		Id: 4/6

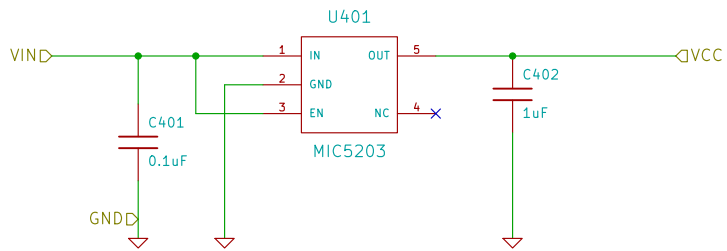

Released under CC-BY-SA 3.0 Unported
<http://creativecommons.org/licenses/by-sa/3.0/>

Fabio Varesano - varesano.net

File: voltage_regulation.sch

Sheet: /Voltage Regulation/

Title: FreeIMU

Size: A4

Date: 10 jul 2011

Rev: 0.3.5_M

KiCad E.D.A.

Id: 5/6

