

Kicad specific stuff for ERC validation.
This doesn't correspond to any specific component.

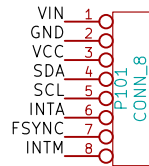

3.3V I2C communication

Pullups enabled by default.
Cut trace on PCB if you don't want them.

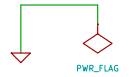
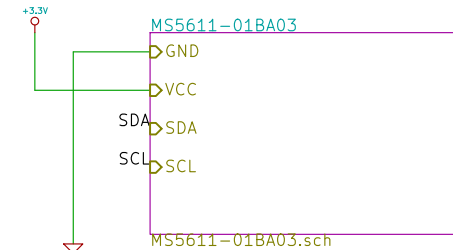
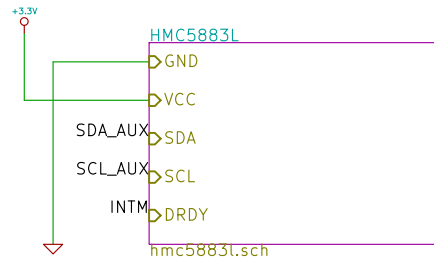
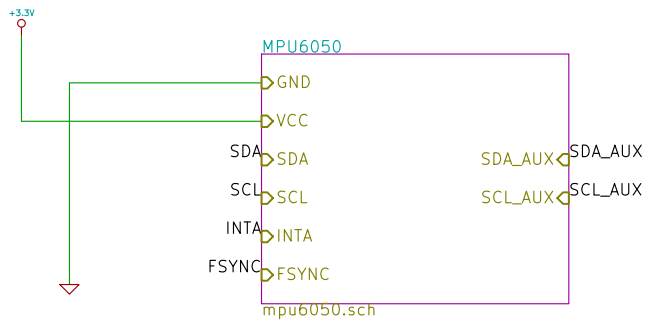
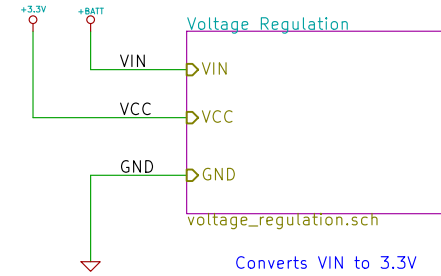
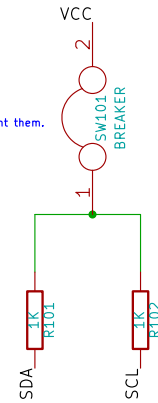

| | | |
|--|-------------------|------------|
| Released under CC-BY-SA 3.0 Unported http://creativecommons.org/licenses/by-sa/3.0/ Fabio Varesano - varesano.net | | |
| File: FreeIMU.sch | | |
| Sheet: / | | |
| Title: FreeIMU | | |
| Size: A4 | Date: 19 oct 2012 | Rev: 0.4r3 |
| KiCad E.D.A. | | Id: 1/5 |

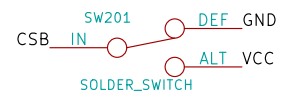
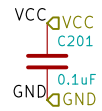
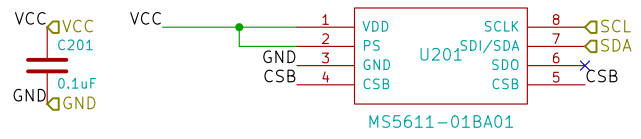

| | | |
|---|-------------------|------------|
| Released under CC-BY-SA 3.0 Unported | | |
| http://creativecommons.org/licenses/by-sa/3.0/ | | |
| Fabio Varesano - varesano.net | | |
| File: MS5611-01BA03.sch | | |
| Sheet: /MS5611-01BA03/ | | |
| Title: FreeIMU | | |
| Size: A4 | Date: 19 oct 2012 | Rev: 0.4r3 |
| KiCad E.D.A. | | Id: 2/5 |

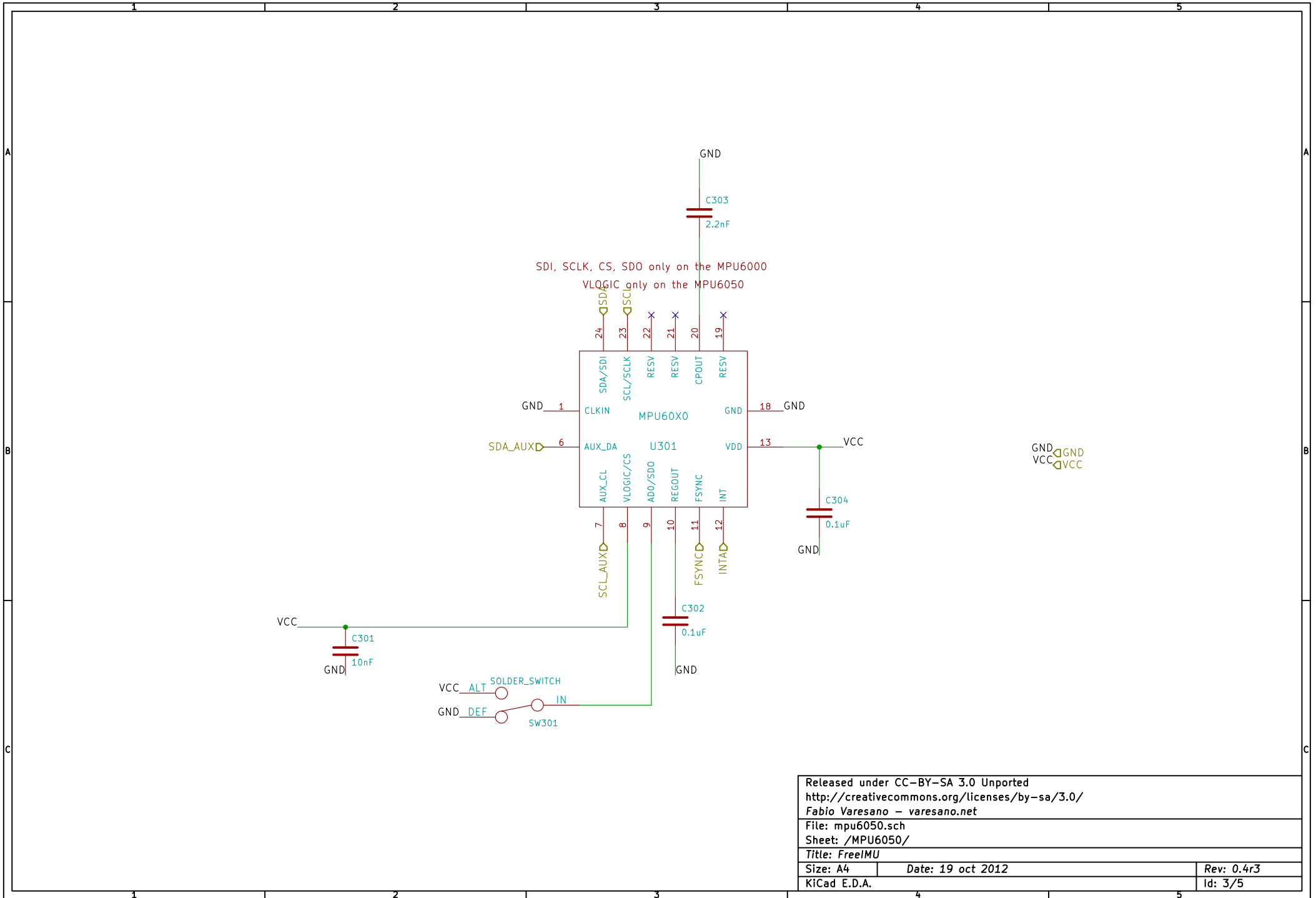

SDI, SCLK, CS, SDO only on the MPU6000
 VLOGIC only on the MPU6050

Released under CC-BY-SA 3.0 Unported
<http://creativecommons.org/licenses/by-sa/3.0/>
 Fabio Varesano - varesano.net
 File: mpu6050.sch
 Sheet: /MPU6050/
 Title: FreeIMU

| | | |
|--------------|-------------------|------------|
| Size: A4 | Date: 19 oct 2012 | Rev: 0.4r3 |
| KiCad E.D.A. | | Id: 3/5 |

1 2 3 4 5

A

A

B

B

C

C

1 2 3 4 5

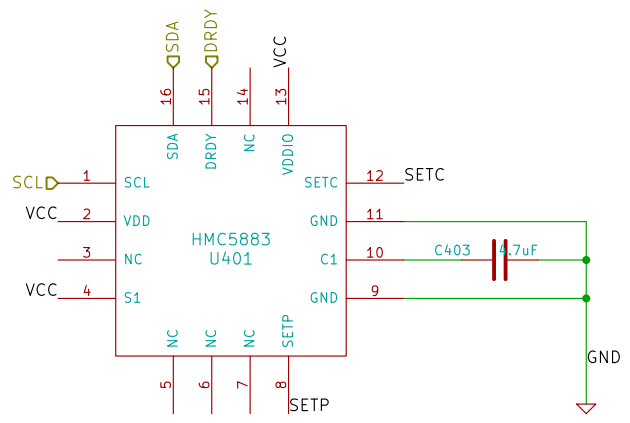
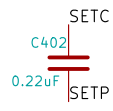
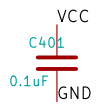

| | | |
|---|-------------------|------------|
| Released under CC-BY-SA 3.0 Unported | | |
| http://creativecommons.org/licenses/by-sa/3.0/ | | |
| Fabio Varesano - varesano.net | | |
| File: hmc5883L.sch | | |
| Sheet: /HMC5883L/ | | |
| Title: FreeIMU | | |
| Size: A4 | Date: 19 oct 2012 | Rev: 0.4r3 |
| KiCad E.D.A. | | Id: 4/5 |

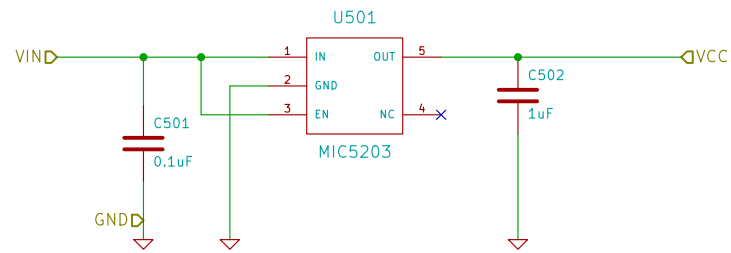

Released under CC-BY-SA 3.0 Unported
<http://creativecommons.org/licenses/by-sa/3.0/>
Fabio Varesano - varesano.net

File: voltage_regulation.sch
Sheet: /Voltage Regulation/

Title: FreeIMU

Size: A4 Date: 19 oct 2012

KiCad E.D.A.

Rev: 0.4r3

Id: 5/5